

User Guide

V9360-6 and V9360-12 Series
Network Panoramic Cameras



XX289-10-02



Vicon Industries Inc. does not warrant that the functions contained in this equipment will meet your requirements or that the operation will be entirely error free or perform precisely as described in the documentation. This system has not been designed to be used in life-critical situations and must not be used for this purpose.

Document Number: 8009-8289-10-02 Product specifications subject to change without notice. Issued: 2/18 Copyright © 2018 Vicon Industries Inc. All rights reserved.

Vicon Industries Inc.
Tel: 631-952-2288) Fax: 631-951-2288
Toll Free: 800-645-9116
24-Hour Technical Support: 800-34-VICON
(800-348-4266) UK: 44/(0) 1489-566300
www.vicon-security.com

Table of Contents

1. Overview	2
1.1 Features	2
1.2 Package Contents	3
1.3 Dimensions	5
1.4 Connectors (Indoor Only)	6
1.5 Function Cables (Outdoor Only)	7
2. Camera Cabling	8
2.1 Power Connection	8
2.2 Ethernet Cable Connection	8
2.3 Connect Alarm I/O	8
2.4 Waterproof Cable Connector (Outdoor Only)	9
2.5 Camera Installation	11
3. System Requirements	12
4. Access Camera	13
5. Setup Video Resolution	17
6. Configuration Files Export / Import	18
7. Tech Support Information	19
7.1 Delete the Existing DCViewer	19
7.2 Setup Internet Security	20
Appendix: Technical Specifications	

Caution: Risk of Explosion if battery is replace by incorrect type. Dispose of used batteries according to the instructions.

The unit and all interconnected equipment must be installed indoors within the same building, including all PoE-powered network connections, as described by Environment A of the IEEE 802.3af standard.

1. Overview

The V9360-6 and V9360-12 Series Panoramic IP Cameras are a high resolution surveillance solution that features 360° wide coverage without blind spots. The panoramic camera supports resolution up to 12 megapixels streaming at 20 fps, which allows the videos to be viewed smoothly. Moreover, the panoramic camera supports digital PTZ, panoramic view and several display modes to fulfill users' needs. With the compact and concise design, the V9360 series is suitable for many kinds of environments, such as office rooms, hotels, vehicles, etc.

Additionally, the embedded edge dewarping engine enables the panoramic camera to dewarp images by the camera rather than the backend system. Therefore, the edge dewarping technique reduces the burden of the backend system and also enhances the flexibility of usage. Featuring IR LED module and Smart Picture Quality/Noise Reduction improves the image quality in low light environments.

Refer to Vicon's website, www.vicon-security.com, to assure you are using the most current documentation and software for the Camera





1.1 Features

- Progressive Scan CMOS Sensor
- Backend Dewarping- up to 12M Resolution
- Edge Dewarping- up to 4M Resolution Real-time
- Quad Streams Compression- H.264 Baseline / Main / High Profile + MJPEG
- Multiple Dewarp Display Modes- Digital PTZ / Panorama View / Quad View
- Smart Event Functions -
Motion Detection / Network Failure Detection / Tampering Alarm / Periodical Event / Manual Trigger Event / Audio Detection
- Multiple and Dynamic Region of Interest (ROI) Windows
- Smart Text Overlay and Privacy Masks
- Day / Night (ICR)
- IR LED Module
- Built-in Microphone & Speaker (indoor only)
- 2D/3D Noise Reduction / Color Noise Reduction
- Weatherproof (IP66 International; outdoor only))*
- microSD and NAS Recording Support
- Compact and Concise Design
- ONVIF Support
- IK10

1.2 Package Contents

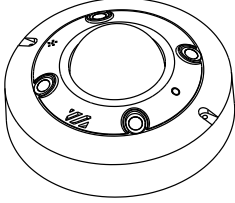
Please check that the package contains the items listed below.

Indoor

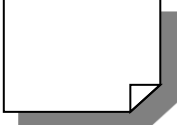
 <p>V9360-6 or V9360-12 IP Camera</p>	 <p>Self-Tapping Screw (x3)</p>	 <p>Plastic Anchor (x3)</p>
 <p>Security Torx</p>	 <p>Power Terminal Block</p>	 <p>Quick Guide</p>









NOTE: The supplied self-tapping screws are for soft substances / materials such as wood. For other installation environments such as cement wall, users **MUST** pre-drill and use plastic anchors before fastening the supplied self-tapping screws on the wall.

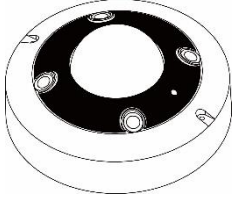

NOTE: To purchase power adaptor, please contact the camera manufacturer for further information.

Outdoor

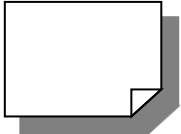
 <p>V9360W-6 or V9360W-12 IP Camera</p>	 <p>Self-Tapping Screw (x3)</p>	 <p>Plastic Anchor (x3)</p>	 <p>Security Torx</p>
 <p>Power Terminal Block</p>	 <p>Alarm I/O Terminal Block</p>		 <p>Quick Guide</p>



NOTE: The supplied self-tapping screws are for soft substances / materials such as wood. For other installation environments such as cement wall, users **MUST** pre-drill and use plastic anchors before fastening the supplied self-tapping screws on the wall.



NOTE: To purchase power adaptor, please contact the camera manufacturer for further information.

1.3 Dimensions

The dimensions of the camera are shown below.

Indoor

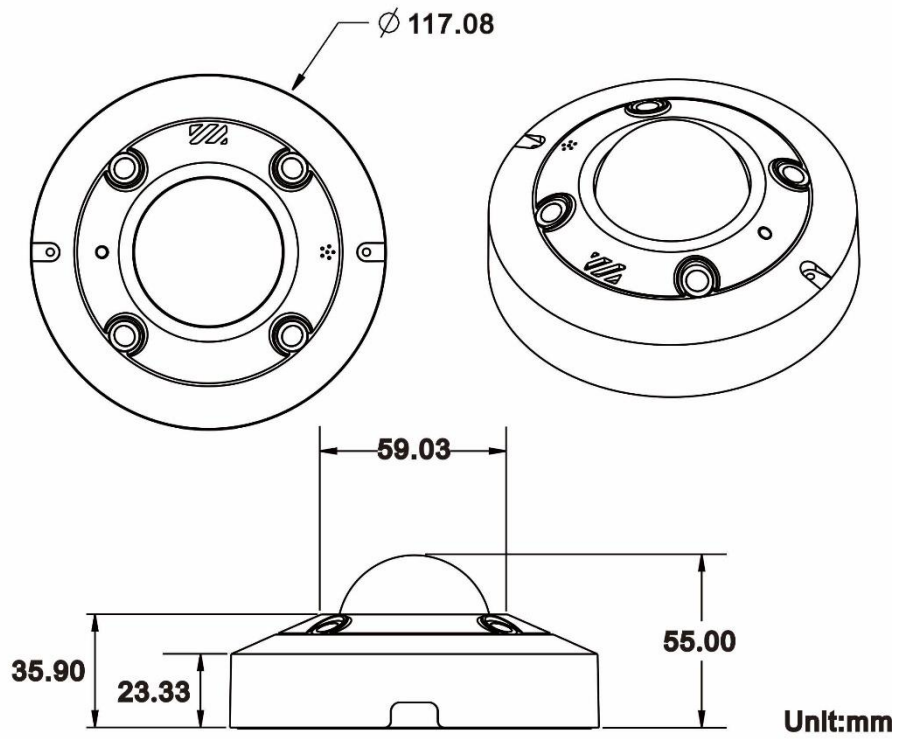

Outdoor

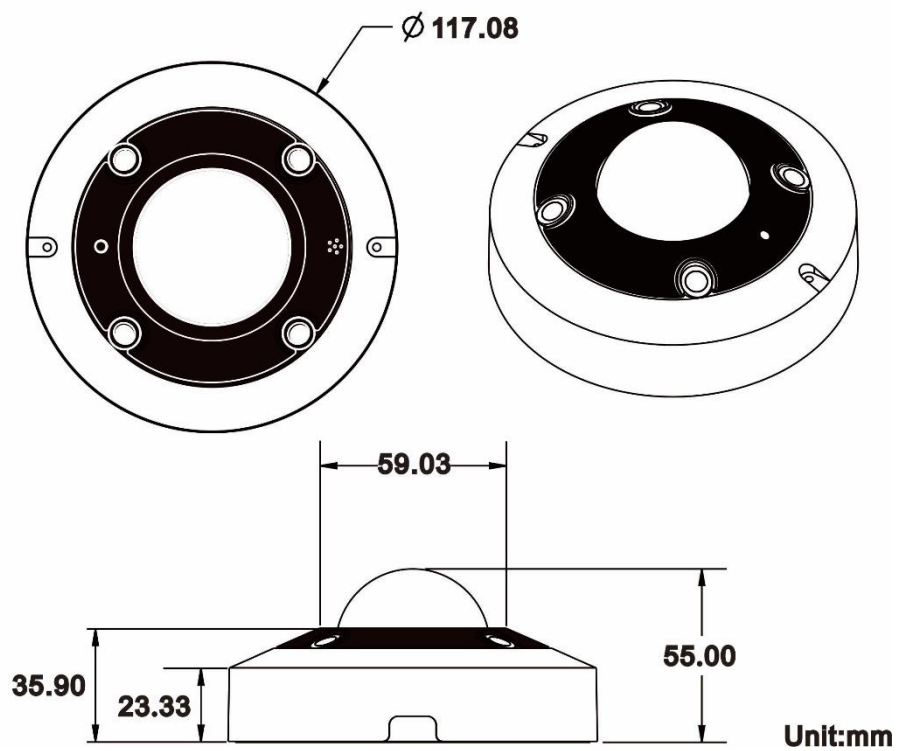

1.4 Connectors (Indoor Only)

Loosen the security screws and open the cover to access the connectors.

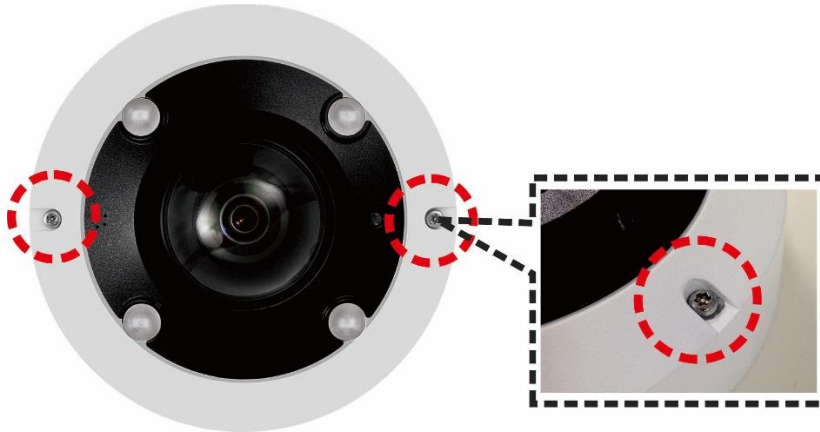

The diagram below shows the connectors of the camera. Each connector is defined as follows.

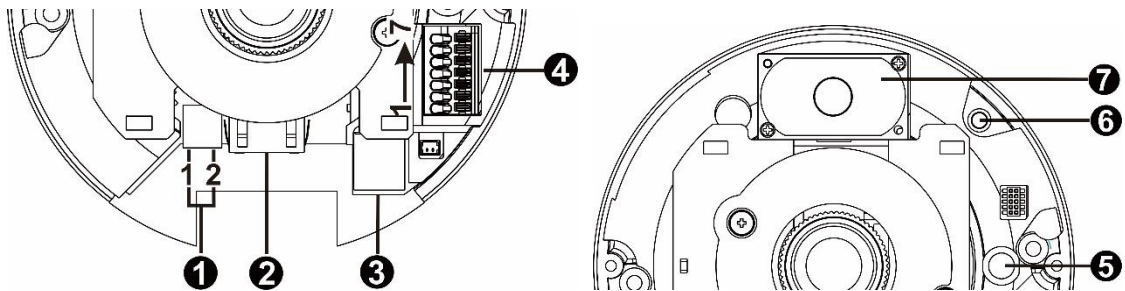

No.	Connector	Pin	Definition	Remarks	
1	Power	12 VDC	1	12 VDC	Power connection
			2	Reserved	
2	RJ-45	-	For network and PoE connections		
3	microSD Card Slot	-	Insert the microSD card into the card slot to store videos and snapshots. Do not remove the microSD card when the camera is powered on.		
4	Alarm & Audio I/O	1	Alarm Out +	Alarm connection	
		2	Alarm Out -		
		3	Alarm In +		
		4	Alarm In -		
		5	GND	Ground connection	
6	Audio Out	6	Audio Out	Two-way audio transmission	
		7	Audio In		
5	Built-in Microphone	-	Audio In		
6	Default Button	-	Press the button with a proper tool for at least 20 seconds to restore the system.		
7	Speaker	-	Audio Out		



NOTE: It is not recommended to record with the microSD card for 24/7 continuously, as it may not be able to support long term continuous data read/write. Please contact the manufacturer of the microSD card for information regarding the reliability and the life expectancy.

1.5 Function Cables (Outdoor Only)

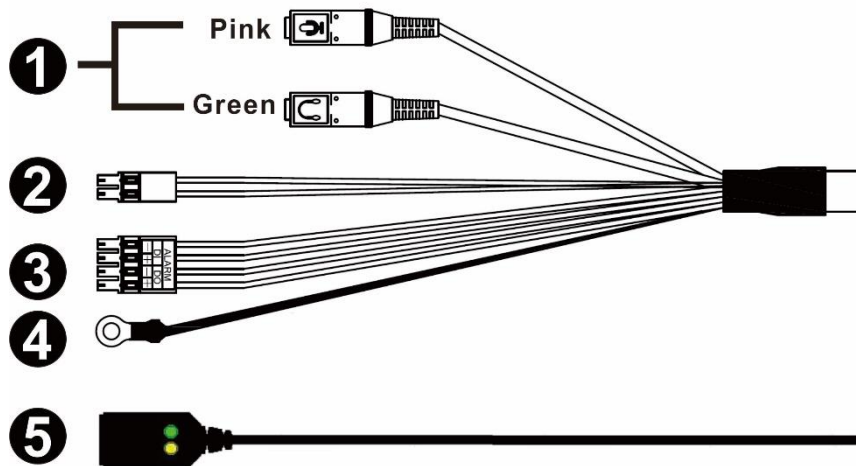

No.	Connector	Pin	Definition	Remarks
1	Audio I/O	Pink	Audio In	Two-way audio transmission
		Green	Audio Out	
2	Power (12 VDC) (2-Pin Terminal Block)	Black	12 VDC -	Power connection
		Red	12 VDC +	
3	Alarm I/O (4-Pin Terminal Block)	1	Alarm In -	Alarm connection
		2	Alarm In +	
		3	Alarm Out -	
		4	Alarm Out +	
4	GND	-	GND	Ground connection
5	RJ-45	-	For network and PoE connections	
-	Default Button	-	Refer to the Default Button in the table under Connectors (Indoor Only).	
-	microSD Card Slot	-	Refer to the microSD Card Slot in the table under Connectors (Indoor Only).	

2. Camera Cabling

Follow the instructions below to complete the cable connections.

2.1 Power Connection

For power connection, refer to section Connectors (Indoor Only) for the indoor models, and see section All in One Cable (Outdoor Only) for the outdoor models. Alternatively, users can power the camera by PoE if a Power Sourcing Equipment (PSE) switch is available. Refer to the section below for Ethernet cable connection.



NOTE: If PoE is used, make sure PSE is in use in the network.

2.2 Ethernet Cable Connection

To have the best transmission quality, cable length should not exceed 100 meters. Connect one end of the Ethernet cable to the RJ-45 connector of the camera and plug the other end of the cable to the network switch or PC.



NOTE: In some cases, Ethernet crossover cable might be needed when connecting the camera directly to the PC.

Check the status of the link indicator and the activity indicator LEDs. If the LEDs are unlit, please check the LAN connection.

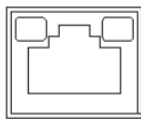

Green Link Light indicates good network connection.

Orange Activity Light flashes for network activity indication.

2.3 Connect Alarm I/O

The camera supports one alarm input and one relay output for alarm application. Refer to Connectors section for pin definitions.



NOTE: Do **NOT** connect external power supply to the alarm I/O connector of the IP camera.

2.4 Waterproof Cable Connector (Outdoor Only)

Follow the instructions below to waterproof the connectors of the different types of cables. The supported cables are as shown below.

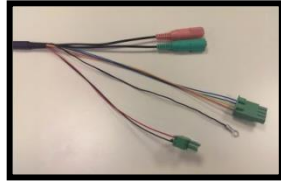

All-in-One Cable



IP66 RJ-45 Cable

All-in-One Cable

Follow the steps below to waterproof the connectors of the All-in-One cable.

Step 1:

Connect the required devices to the All-in-One cable and coat the joints with silicone gel. There should be no gap between the connectors and the cables. For the alarm I/O connector and the power connector, make sure the side with wires attached is also sealed with silicone gel.

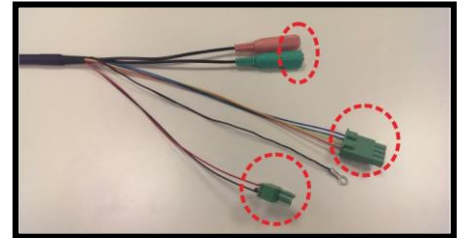

In addition, attach the ground cable to the ground and wrap the wires with silicone gel. Make sure the wires are not exposed to the air.

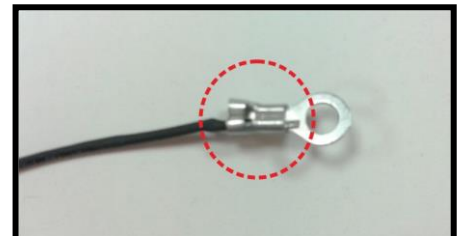

Step 2:

Seal the end of the rubber coating of the All-in-One cable as indicated in the figure on the right. Be sure to use enough silicone gel to fill in the hose and wrap around each wire; otherwise, waterproof function cannot be guaranteed.

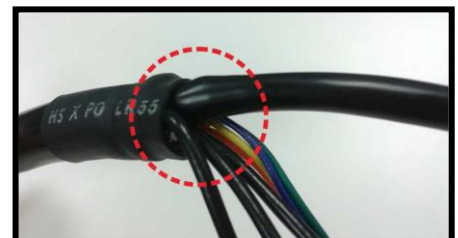

IP66 RJ-45 Cable

For IP66 RJ-45 cable, use an RJ-45 IP66 plug for connection to prevent water damage. Follow the steps below for cable connection.

Step 1:

Take out the supplied connector from the RJ-45 IP66 plug. Loosen the thread-lock sealing nut on the plug. Then thread the Ethernet cable through the thread-lock sealing nut and the plug. If the Ethernet cable is already attached to a connector, be sure to remove it first.

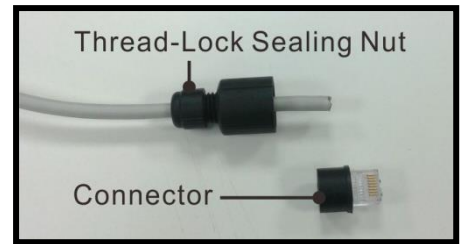

Step 2:

Carefully remove a section of rubber coating from the end of the Ethernet cable to reveal the wires. Inset the wires to the correct pins of the connector. Plug the Ethernet cable to the connector of the IP66 RJ-45 cable.



Step 3:

Fasten the RJ-45 IP66 plug to the connector of the IP66 RJ-45 cable. Lastly, tighten the thread-lock sealing nut to the plug.



2.5 Camera Installation

The following description demonstrates how to directly install the camera to the ceiling or to the wall.

Step 1:

Loosen the two security screws on the camera with the supplied security torx and open the dome cover.



Step 2:

Place the camera at the installation location. Mark the position of the two screw holes, indicated in the figure to the right, on the ceiling/wall. Then draw a line along the concave edge of the camera to indicate the cable position.



Step 3:

On the ceiling/wall, draw a dot 0.78 in. (20mm) above the center of the marked concave edge. Set the marked dot as the center, draw a cable entry hole with 1.18 in. (30mm) diameter [radius is 0.59 in. (15mm)] and drill the cable entry hole.

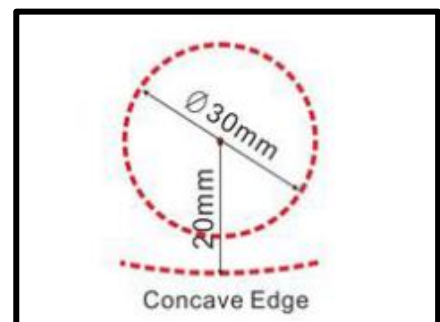

Step 4:

Drill a hole slightly smaller than the supplied plastic screw anchor on each marked screw hole. Then insert the plastic screw anchors into the drilled holes.

Step 5:

Thread the cables through the cable entry hole. Match the two screw holes on the camera with the plastic screw anchors at the installation location. Fasten the camera with the supplied self-tapping screws.

Step 6:

Attach the dome cover to the camera and fasten the two security screws.

3. System Requirements

To perform the IP camera via web browser, please ensure the PC is in good network connection, and meet system requirements as described below.

Items	System Requirement
Personal Computer	Minimum : 1. Intel® Core™ i5-2430M @ 2.4 GHz 2. 4 GB RAM
	Recommended: 1. Intel® Core™ i7-870 @ 2.93 GHz 2. 8 GB RAM
Operating System	Windows VISTA / Windows XP / Windows 7
Web Browser	Microsoft Internet Explorer 7.0 or later (recommended) Firefox (32-bit) Safari
Network Card	10Base-T (10 Mbps) or 100Base-TX (100 Mbps) or 1000Base-T (1000 Mbps) operation
Viewer	ActiveX control plug-in for Microsoft IE Apple QuickTime 7.7.7 or before for Firefox



NOTE: The camera is to be connected only to PoE networks without routing to the outside plant or equivalent location.

4. Access Camera

For initial access to the IP camera, users can search for the camera using the V9360-6/V9360-12 Discovery Tool (DeviceSearch.exe), which can be found on Vicon's website, www.vicon-security.com on the Software Downloads page.

Accessing the Camera by Device Search Software

- Step 1:** Download V9360-6/V9360-12 Discovery Tool (DeviceSearch.exe) from the website. Double click on the program DeviceSearch.exe.
- Step 2:** After its window appears, click on the <Device Search> button on the top. All the IP devices found will be listed in the page.
- Step 3:** Find the camera in the list by its IP address and click on it. By factory default, the camera is set to obtain the IP address automatically via DHCP server. If your network does not have a DHCP server, the camera will use APIPA (Automatic Private IP Addressing; link-local address).
- Step 4:** The default IP address of the camera may not be in the same LAN as the IP address of the PC. If so, the IP address of the camera needs to be changed. Right click on the camera and click <Network Setup>. Meanwhile, record the MAC address of the camera, for future identification.
- Step 5:** The <Network Setup> page will display. Select <DHCP> and click <Apply> at the bottom of the page. The camera will be assigned a new IP address.
- Step 6:** Click <OK> on the Note of setting change. Wait about one minute as it re-searches for the camera.
- Step 7:** Click on the <Device Search> button to re-search all the devices. Find the camera in the list by its MAC address. Then double click or right click and select <Browse> to access the camera directly via a web browser.

Step 8: A prompt window requesting for default username and password will appear. Enter the default username and password shown below to login to the camera.

Login ID	Password
ADMIN	1234



NOTE: ID and password are case sensitive.



NOTE: It is strongly advised that the administrator's password be changed for the security concerns. Refer to the [V9360 IP Camera Menu Tree](#) document for further details.

Installing DCViewer Software Online

For initial access to the camera, a client program, DCViewer, will be automatically installed to the PC when connecting to the camera.

If the web browser doesn't allow DCViewer installation, check the Internet security settings or ActiveX controls and plug-ins settings (refer to section [Setup Internet Security](#)) to continue the process.

The Information Bar (just below the URL bar) may pop up and ask for permission to install the ActiveX Control for displaying video in browser. Right click on the Information Bar and select <Install ActiveX Control...> to allow the installation.

The download procedure of DCViewer software is specified as follows.

Step 1: In the DCViewer installation window, click on <Next> to start installation.

Step 2: The status bar will show the installation progress. After the installation is completed, click on <Finish> to exit the installation process.

Step 3: Click on <Finish> to close the DCViewer installation page.

Once the Viewer is successfully installed, the Home page of the IP camera will be shown as the figure below.

Note: When using the V9360-6/V9360-12 camera with Vicon Valerus™, the default settings for Manufacturer of Immervision and B9VVT for Lens type must be used.

Ceiling Mount Installed Camera

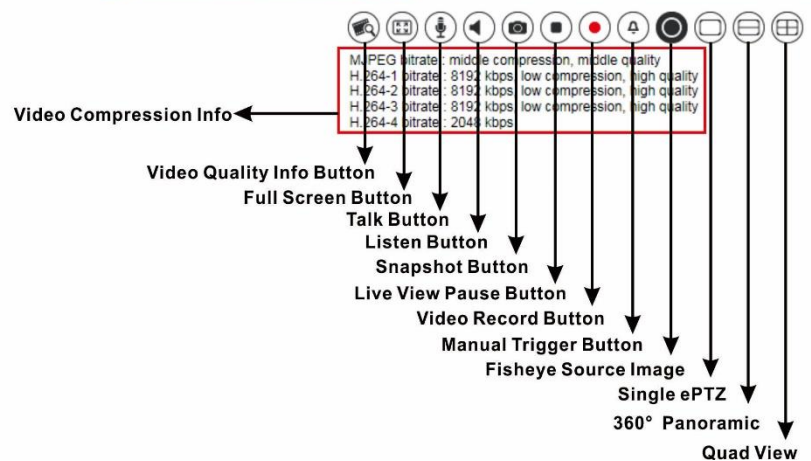
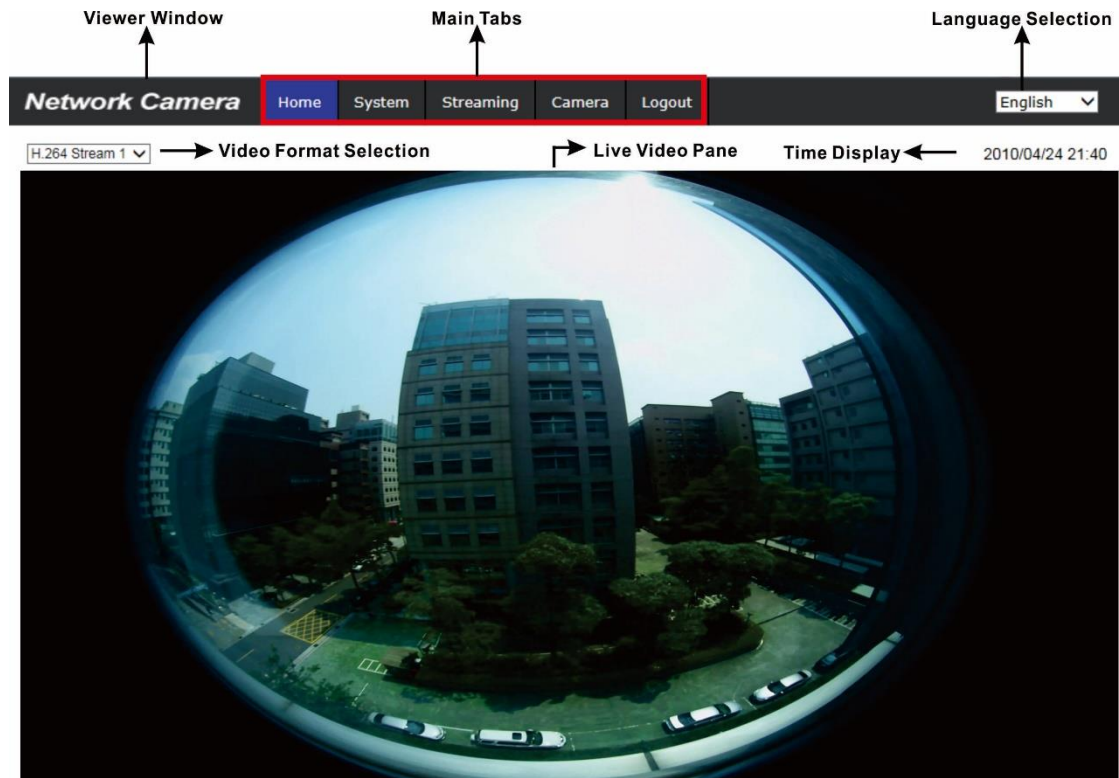

Wall Mount Installed Camera

Viewer Window

Main Tabs

Language Selection

Network Camera

Home System Streaming Camera Logout

English

H.264 Stream 1

Video Format Selection

Live Video Pane

Time Display

2010/04/24 22:39

MPEG	bitrate: middle compression, middle quality
H.264-1	bitrate: 8192 kbps low compression, high quality
H.264-2	bitrate: 8192 kbps low compression, high quality
H.264-3	bitrate: 8192 kbps low compression, high quality
H.264-4	bitrate: 2048 kbps

Video Compression Info

Video Quality Info Button

Full Screen Button

Talk Button

Listen Button

Snapshot Button

Live View Pause Button

Video Record Button

Manual Trigger Button

Fisheye Source Image

180° Panoramic

Dual ePTZ



NOTE: For more details about the function buttons on the Home page, please refer to [V9360 IP Camera Menu Tree](#) on the Vicon website, vicon-security.com.

5. Setup Video Resolution

Users can setup video resolution on Video Format page of the user-friendly browser-based configuration interface.

Video Format can be found under this path: **Streaming> Video Format**.

The default video resolution of 6 MP and 12 MP models are shown below.

6 MP Back End	H.264 - 3072 x 2048 (30/25 fps)
12 MP Back End	H.264 - 4000 x 3000 (20 fps)



NOTE: For more details about the combinations of video resolution, please refer to the [V9360 IP Camera Menu Tree](#) on the Vicon website.

6. Configuration Files Export / Import

To export / import configuration files, users can access the Maintenance page on the user-friendly browser-based configuration interface.

The Maintenance setting can be found under this path: **System> Maintenance**.

Users can export configuration files to a specified location and retrieve data by uploading an existing configuration file to the camera.

Export

Users can save the system settings by exporting the configuration file (.bin) to a specified location for future use. Click on the <Export> button, and the popup File Download window will display. Click on <Save> and specify a desired location for saving the configuration file.

Upload

To upload a configuration file to the camera, click on <Browse> to select the configuration file, and then click on the <Upload> button for uploading.

7. Tech Support Information

This chapter will explain how to delete previously-installed Viewer in the PC and how to setup the Internet security.

7.1 Delete the Existing DCViewer

For users who have installed the DCViewer in the PC previously, remove the existing DCViewer from the PC before accessing to the IP camera.

Deleting the DCViewer

In the Windows <Start Menu>, activate <Control Panel>, and then double click on <Add or Remove Programs>. In the <Currently installed programs> list, select <DCViewer> and click on the button <Remove> to uninstall the existing DCViewer.

Deleting Temporary Internet Files

To improve browser performance, it is suggested to clean up all the files in the <Temporary Internet Files>. The procedure is as follows.

Step 1: In the web browser, click on the <Tools> tab on the menu bar and select <Internet Options>.

Step 2: Click on the <Delete> button under <Browsing History> section. In the display window, tick the box beside the <Temporary Internet files>.

Step 3: Click on <Delete> to start deleting the files.

7.2 Setup Internet Security

If ActiveX control installation is blocked, either set Internet security level to default or change ActiveX controls and plug-ins settings.

Internet Security Level: Default

Step 1: Start the Internet Explorer (IE).

Step 2: Click on the <Tools> tab on the menu bar and select <Internet Options>.

Step 3: Click on the <Security> tab and select <Internet> zone.

Step 4: Down on the page, click on the <Default Level> button and click on <OK> to confirm the setting. Close the browser window; restart a new page later to access the camera.

ActiveX Controls and Plug-ins Settings

Step 1: Repeat **Step 1 to Step 3** of the previous section above.

Step 2: Down on the page, click on the <Custom Level> button to change ActiveX controls and plug-ins settings. The Security Settings window will pop up.

Step 3: Under <ActiveX controls and plug-ins>, set **ALL** items (as listed below) to <Enable> or <Prompt>. Please note that the items vary by IE version.

ActiveX controls and plug-ins settings:

1. Binary and script behaviors.
2. Download signed ActiveX controls.
3. Download unsigned ActiveX controls.
4. Allow previously unused ActiveX controls to run without prompt.
5. Allow Scriptlets.
6. Automatic prompting for ActiveX controls.
7. Initialize and script ActiveX controls not marked as safe for scripting.
8. Run ActiveX controls and plug-ins.
9. Only allow approved domains to use ActiveX without prompt.
10. Script ActiveX controls marked safe for scripting*.
11. Display video and animation on a webpage that does not use external media player.

Step 4: Click on <OK> to accept the settings. A prompt window will appear to confirm the setting changes; click <Yes(Y)> to close the Security Setting window.

Step 5: Click on <OK> to close the Internet Options screen.

Step 6: Close the browser window; restart a new page later to access the camera.